

# Complexité du problème de distance d'édition minimum à un line-digraphe

Journées Graphes et Algorithmes 2023  
Session graphes orientés

Quentin Japhet

Encadrants : Dominique Barth, Dimitri Watel, Marc-Antoine Weisser



# Connection entre cable

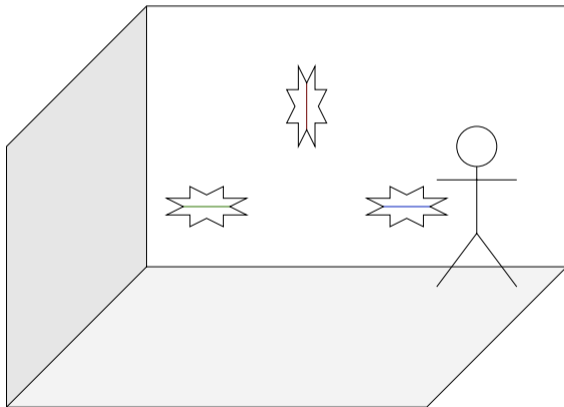

# Connection entre cable

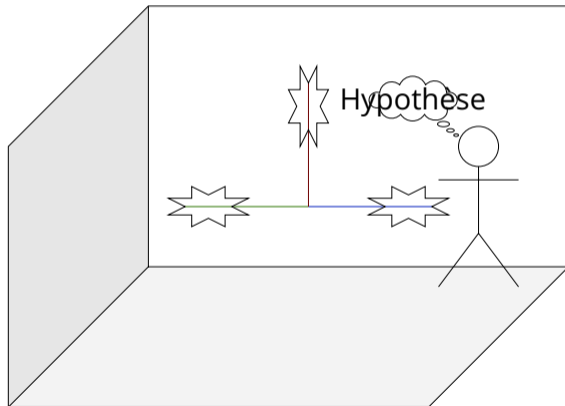

# Connection entre cable

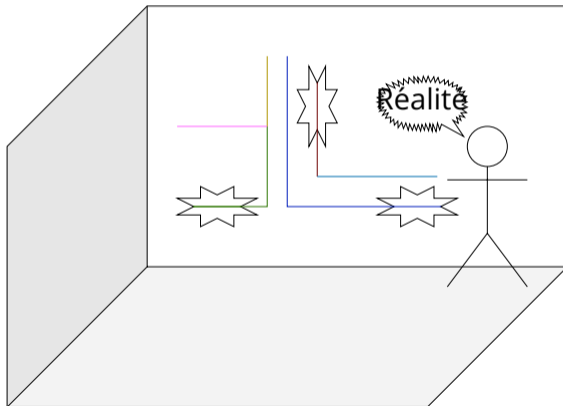

# Connection entre cable

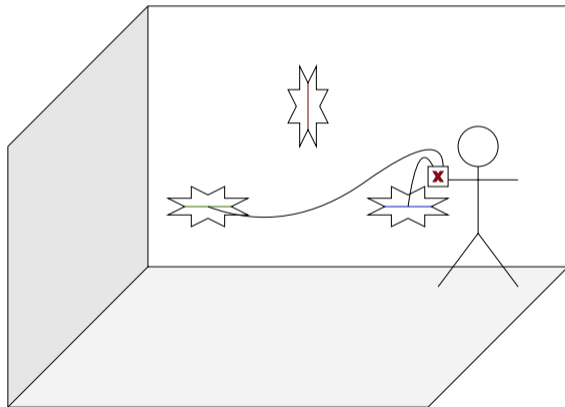

# Connection entre cable

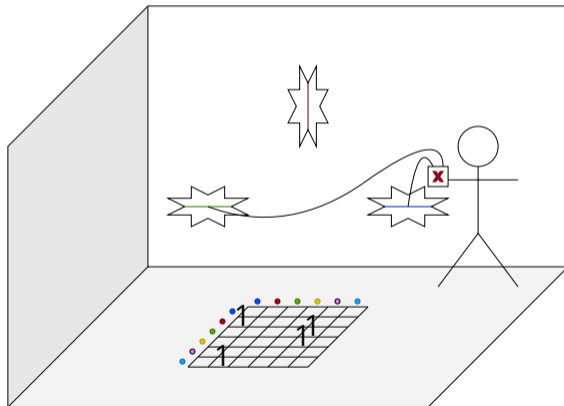

Line-Digraphe

# Line-digraphe

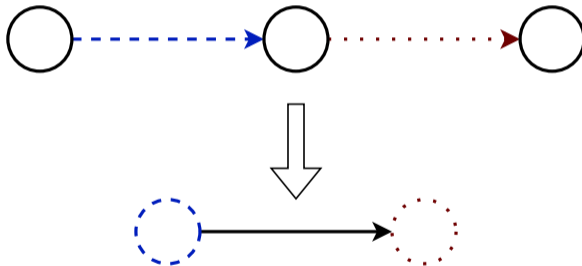

Line-Digraphe

# Transformation

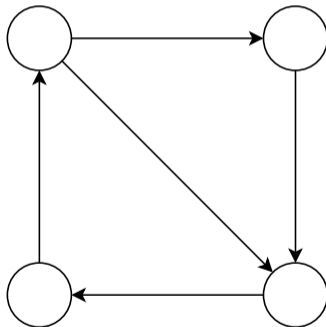



Line-Digraphe

# Transformation

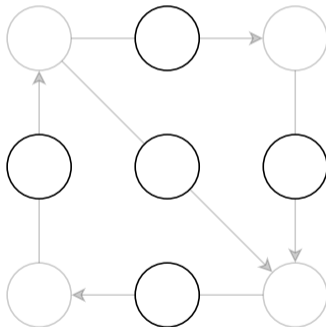

Line-Digraphe

# Transformation

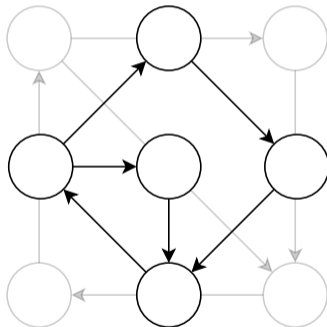

# Transformation

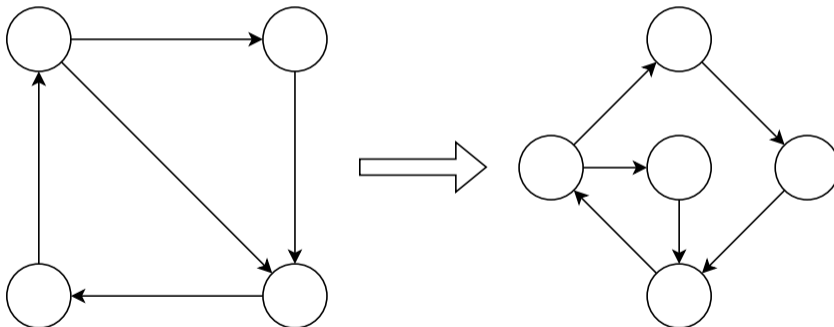

# Caractérisation par sous-digraphes interdits

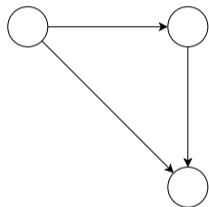

Raccourci

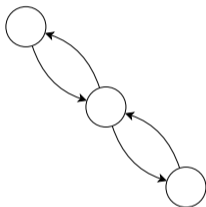

Huit

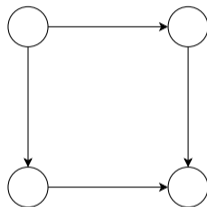

Déviation

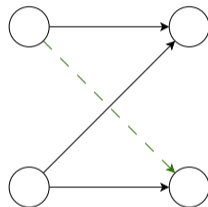

Z

- Circuit de taille 2 autorisé
- Boucle interdite

W. Beineke. Derived graphs and digraphs. Beiträge zur graphentheorie, 1968

# Z interdiction conditionnel

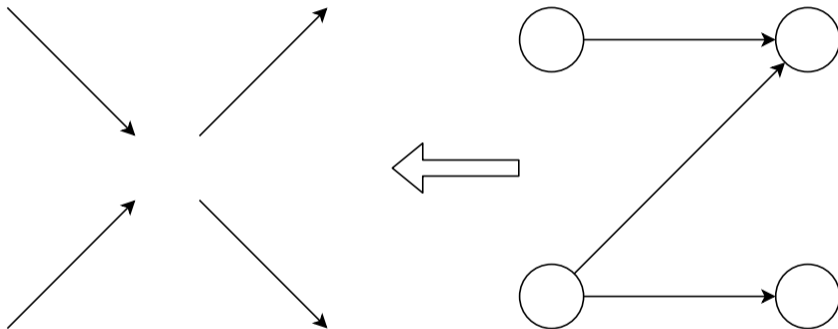

- Circuit de taille 2 autorisé
- Boucle interdite

# Z interdiction conditionnel

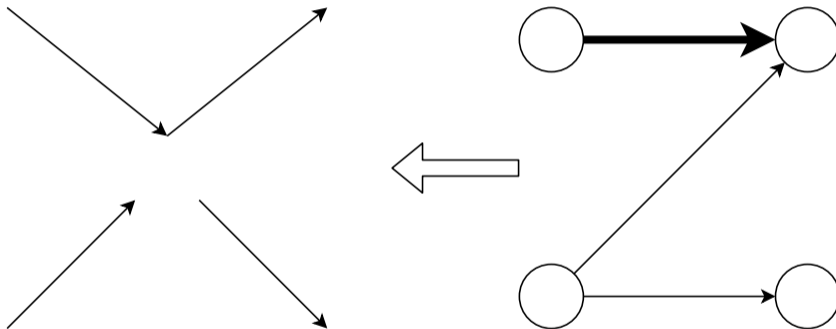

- Circuit de taille 2 autorisé
- Boucle interdite

# Z interdiction conditionnel

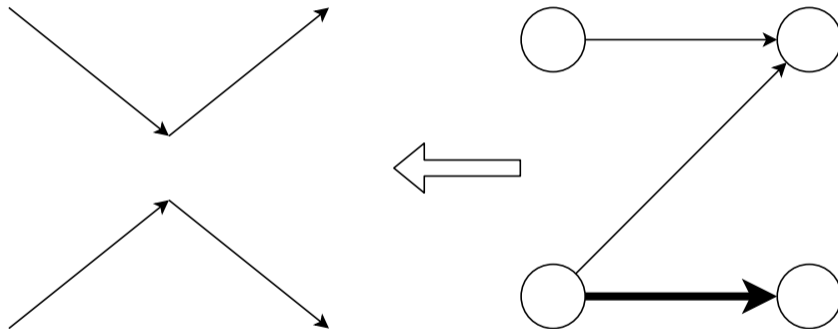

- Circuit de taille 2 autorisé
- Boucle interdite

# Z interdiction conditionnel

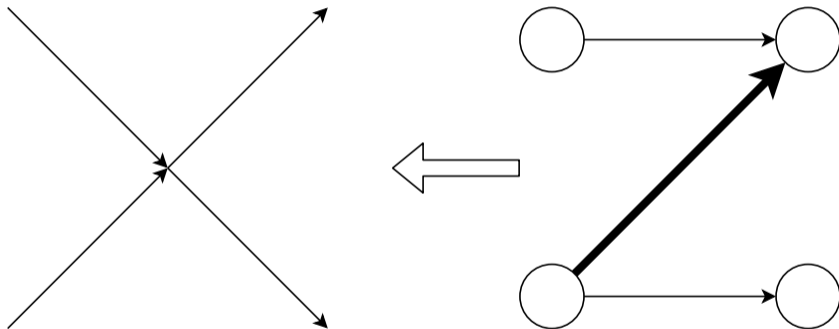

- Circuit de taille 2 autorisé
- Boucle interdite



# Z interdiction conditionnel

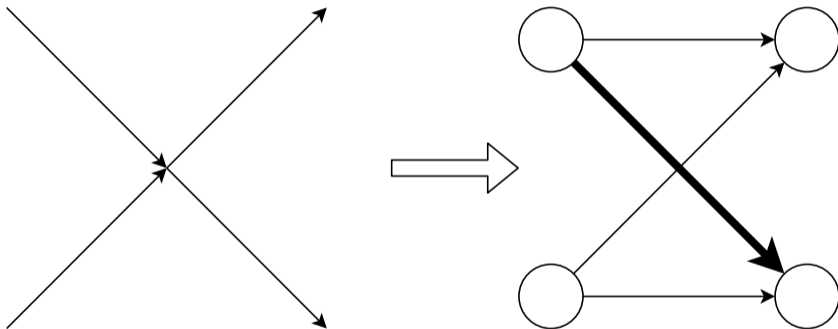

- Circuit de taille 2 autorisé
- Boucle interdite

# Caractérisation par couverture en biparti complet

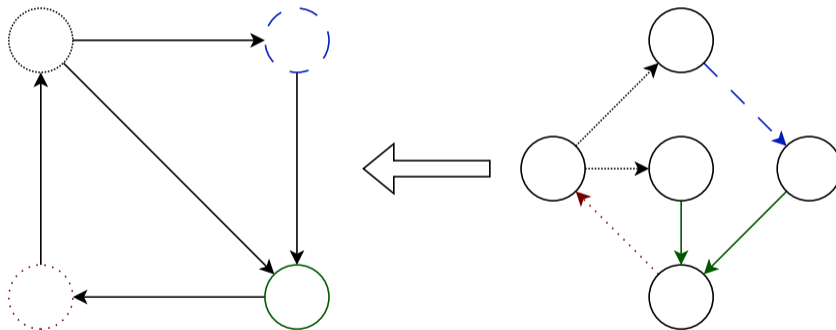

Frank Harary & Robert Z. Norman. Some properties of line digraphs.  
Rendiconti del Circolo Matematico di Palermo 1960

# Formalisation du problème

Soit un digraphe  $D$  et un entier  $k$ . Existe-t-il un graphe  $D'$  avec les mêmes sommets que  $D$  tel que  $D'$  soit un line-digraphe et que la distance de Hamming entre  $D$  et  $D'$  soit inférieure ou égale à  $k$ ?

# Complexité

Complétion	?
Suppression	?
Édition	?

# Ajout d'arcs

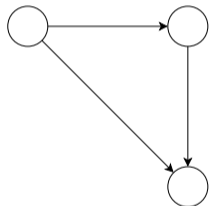

Raccourci

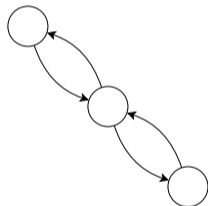

Huit

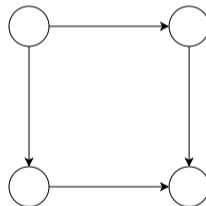

Déviation

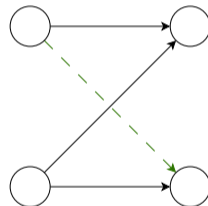

Z

# Complexité

Complétion	P
Suppression	?
Édition	?

Réduction

# Retrait d'arcs

R



H



D



Z

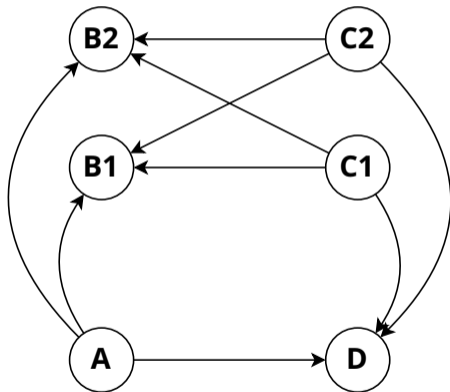

Réduction

# Retrait d'arcs

R



H



D



Z

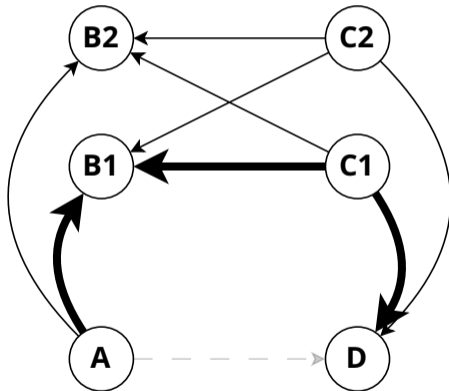



Réduction

# Retrait d'arcs

R



H



D



Z

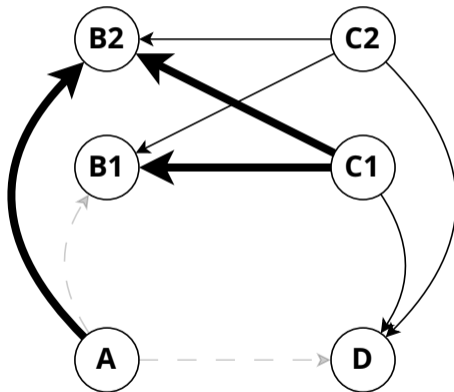

Réduction

# Retrait d'arcs

R



H



D



Z

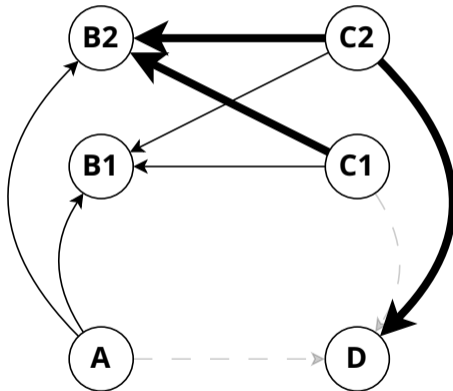

Réduction

# Retrait d'arcs

R



H



D



Z

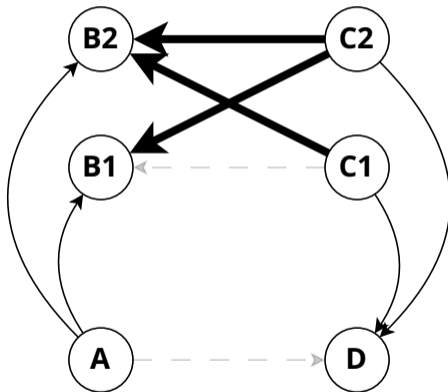

# Réduction

Réduction depuis Monotone-3SAT, où toutes les clauses contiennent strictement trois littéraux.

$$(X_1 \vee X_2 \vee X_3) \wedge (\neg X_2 \vee \neg X_3 \vee \neg X_4) \wedge (X_2 \vee X_3 \vee X_4) \wedge (\neg X_1 \vee \neg X_3 \vee \neg X_5)$$

# Gadget de littéral

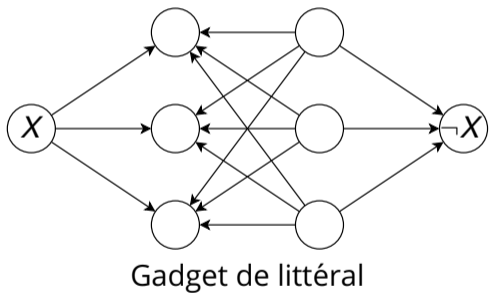
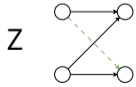
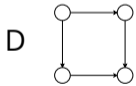
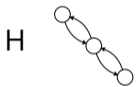
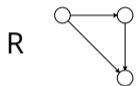

# Gadget de littéral

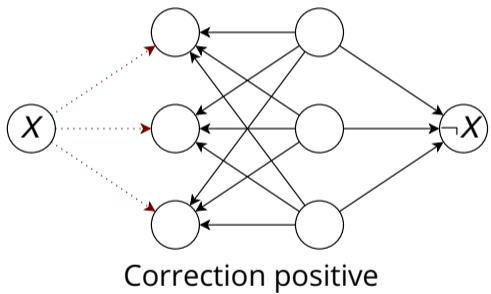
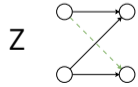
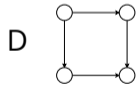
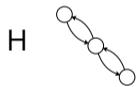
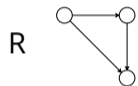

# Gadget de littéral

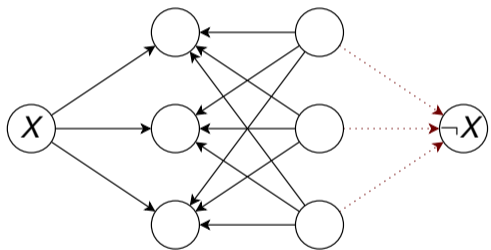
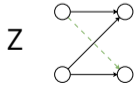
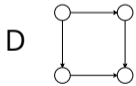
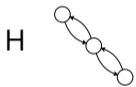
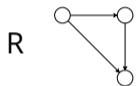

Correction négative

# Gadget de littéral

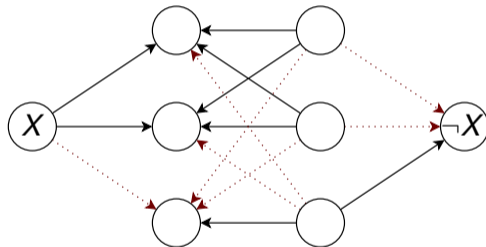
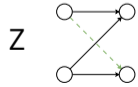
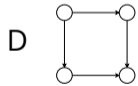
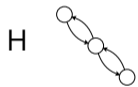
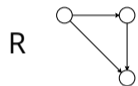

Correction anormale



# Gadget de littéral

R



H



D



Z

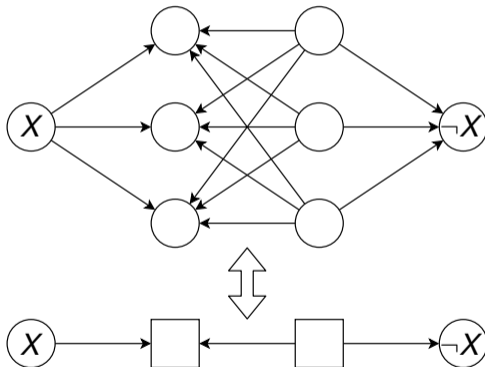

# Gadget de clause

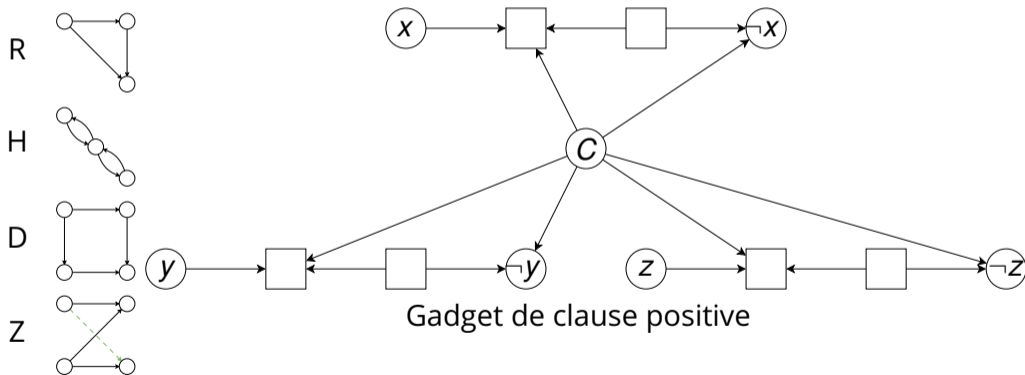

# Gadget de clause

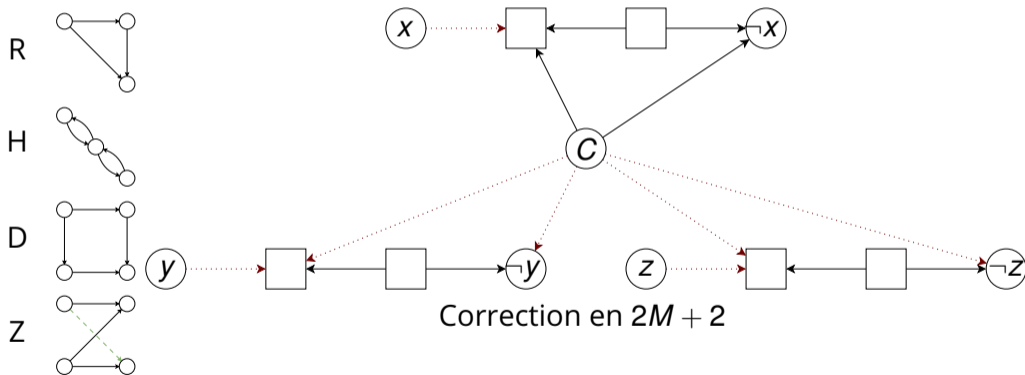

# Gadget de clause

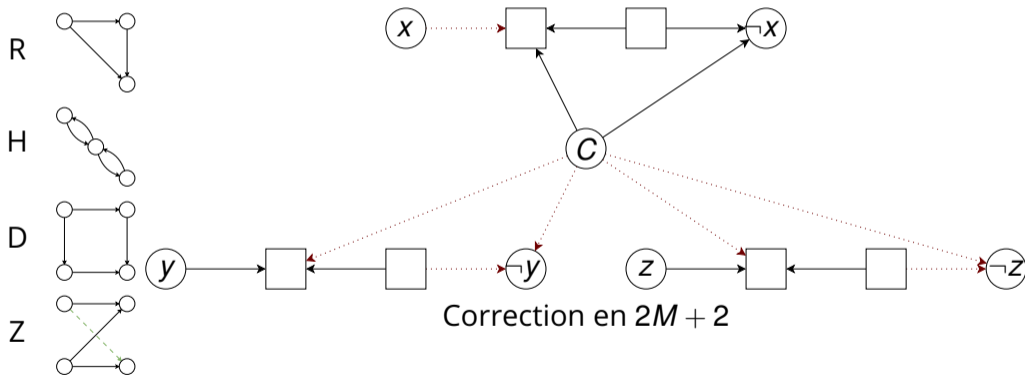

# Gadget de clause

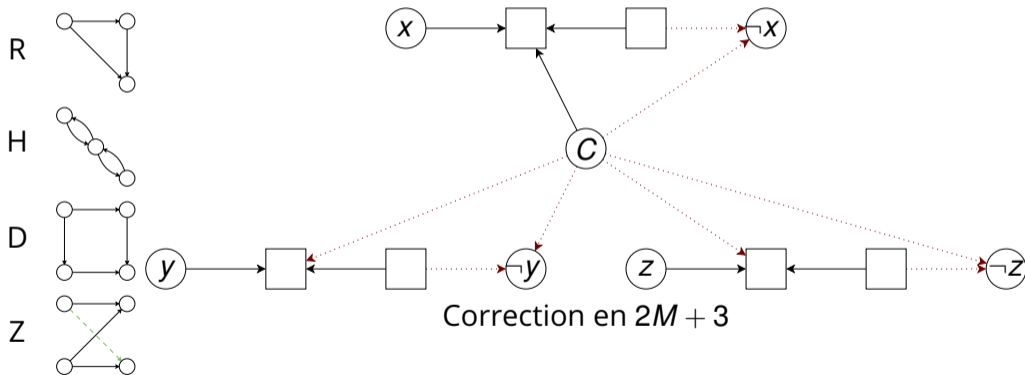

# Complexité

Complétion	P
Suppression	NP-C
Édition	?

Réduction

# Réduction composé uniquement de Z

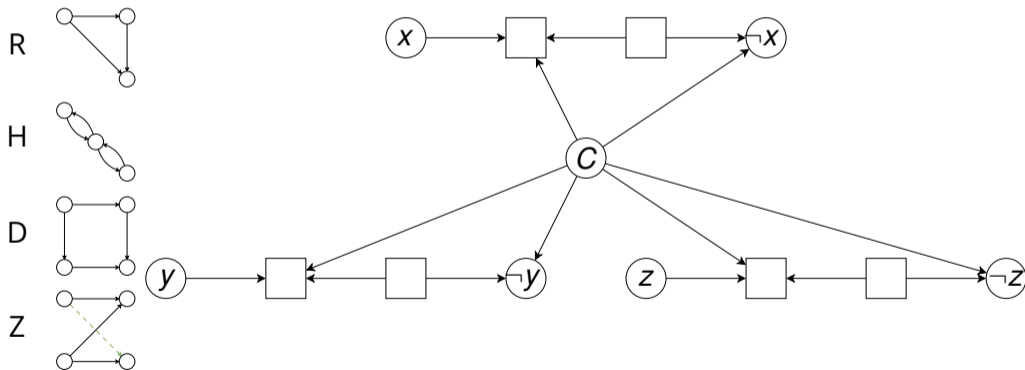

# Complexité

Complétion	P
Suppression	NP-C
Édition	?
Sup : aucun Z	?
Sup : nombre de Z fixé	?
Sup : nombre de Z hors $K_{2,2}$ fixé	?



Problème de suppression sans Z

# Cas sans Z

R



H



D



Z

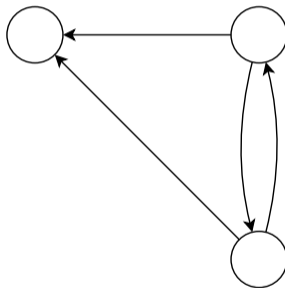

Problème de suppression sans Z

# Cas sans Z

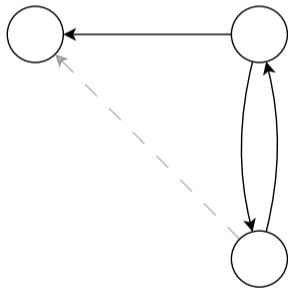
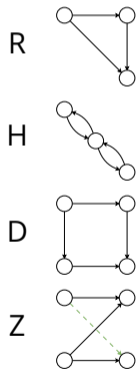

Solution mimimum

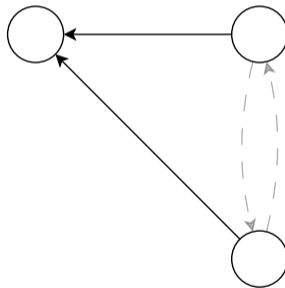

Solution mimimale

Problème de suppression sans Z

# Cas sans Z, extension

R



H



D



Z

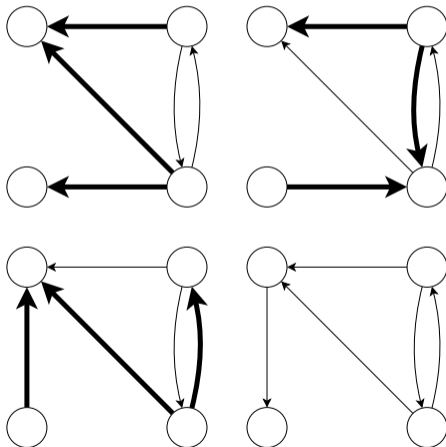

Problème de suppression sans Z

# Cas sans Z, intersection possible entre R, H et D

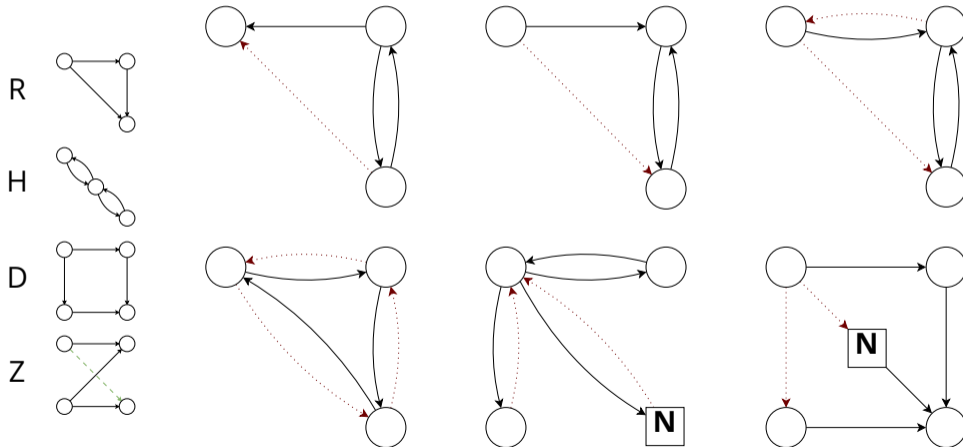

# Complexité

Complétion	P
Suppression	NP-C
Édition	?
Sup : aucun Z	P
Sup : nombre de Z fixé	?
Sup : nombre de Z hors $K_{2,2}$ fixé	?

# Décompte des Z

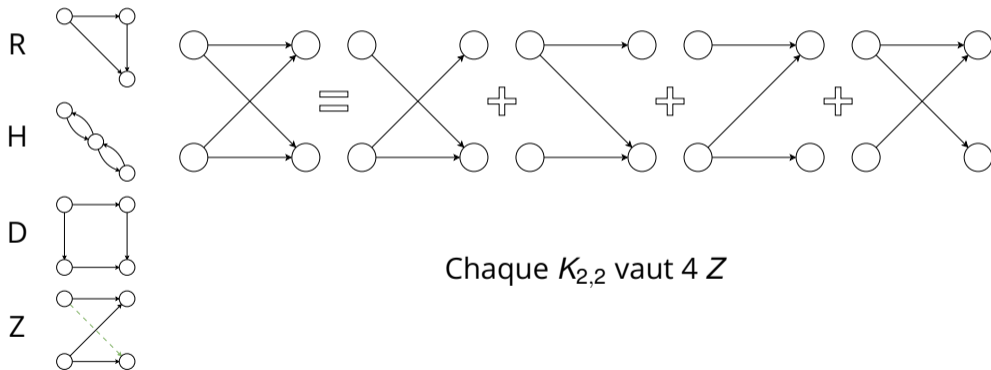

Problème de suppression avec k Z

# Complexité paramétrée en fonction du nombre fixé de Z

R



H



D



Z

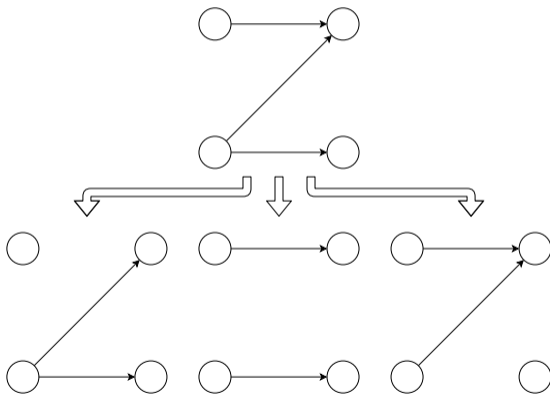

# Complexité paramétrée en fonction du nombre fixé de Z

R



H



D



Z

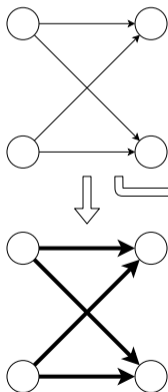

Retrait de deux arcs



# Problème de suppression avec $K_{2,2}$ bloqués

R



H



D



Z



75 sous-digraphes possible à corriger

# Complexité

Complétion	P
Suppression	NP-C
Édition	?
Sup : aucun Z	P
Sup : nombre de Z fixé	FPT(k)
Sup : nombre de Z hors $K_{2,2}$ fixé	?

# Conclusion

- Problème de reconstruction de topologie de réseau orienté
- Plusieurs résultats de complexité
- Plusieurs variante à regarder
- Approximabilité du problème?
- Ajout d'informations supplémentaires?

# Line-digraphes isomorphes

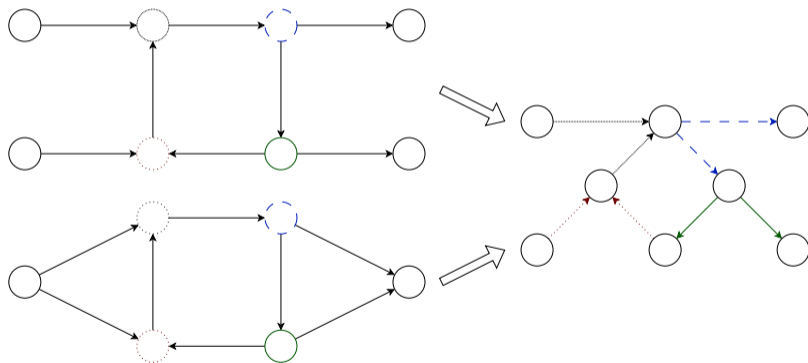

# Racourci : interdiction

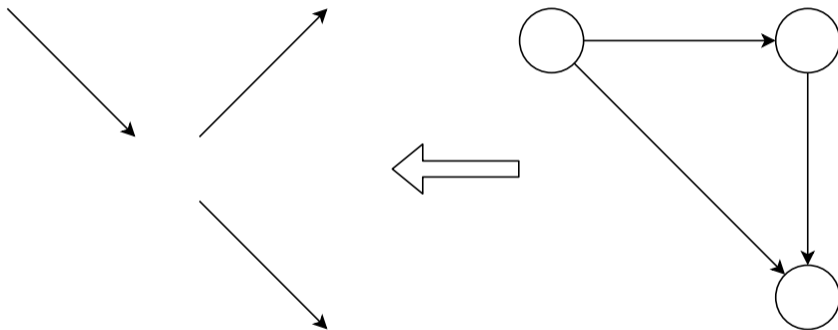

- Circuit de taille 2 autorisé
- Boucle interdite

# Racourci : interdiction

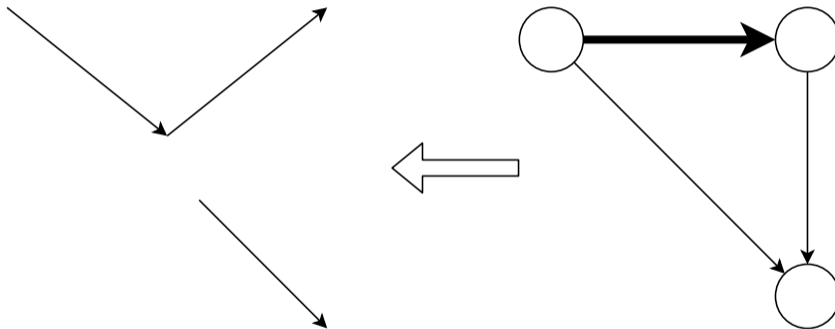

- Circuit de taille 2 autorisé
- Boucle interdite

## Racourci : interdiction

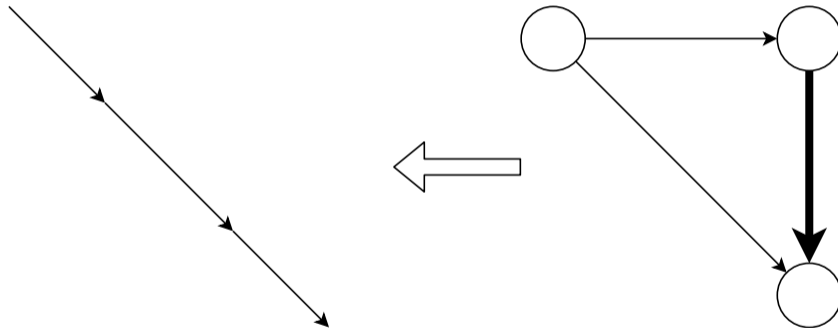

- Circuit de taille 2 autorisé
- Boucle interdite

## Racourci : interdiction

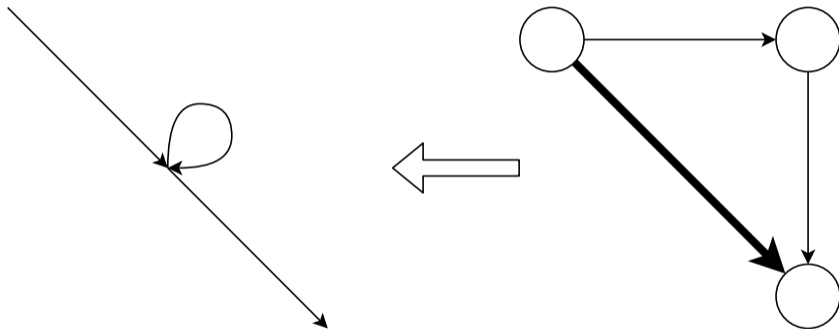

- Circuit de taille 2 autorisé
  - Boucle interdite



## Racourci : interdiction

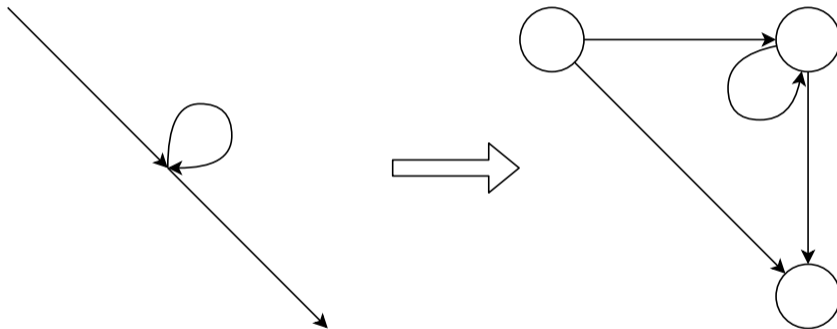

- Circuit de taille 2 autorisé
  - Boucle interdite

## Déviation : interdiction

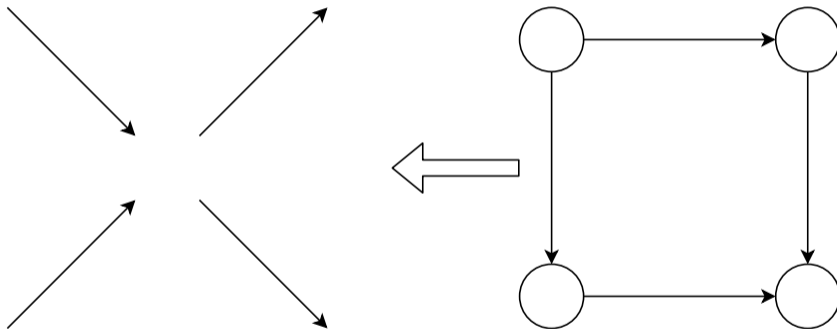

- Circuit de taille 2 autorisé
- Boucle interdite

# Déviation : interdiction

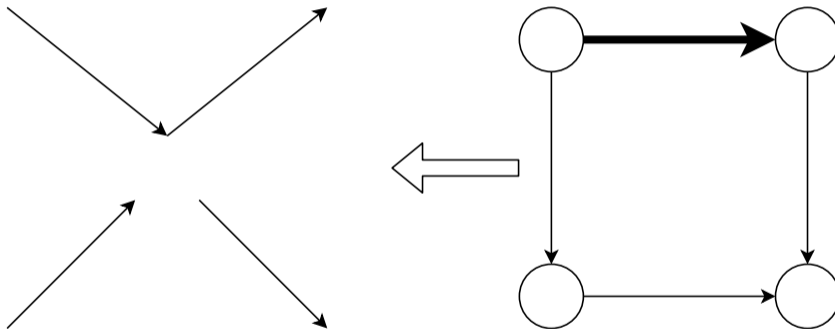

- Circuit de taille 2 autorisé
- Boucle interdite

# Déviation : interdiction

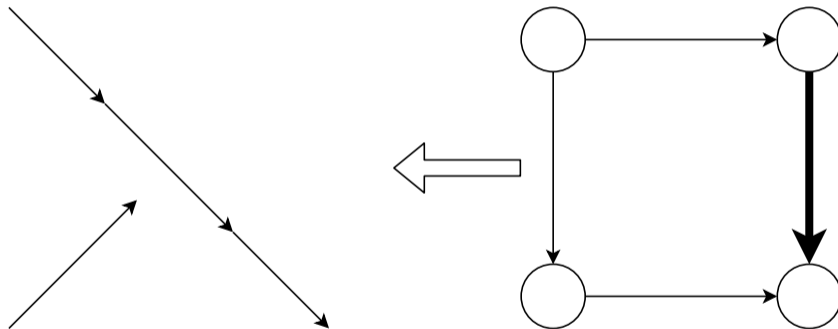

- Circuit de taille 2 autorisé
- Boucle interdite

# Déviation : interdiction

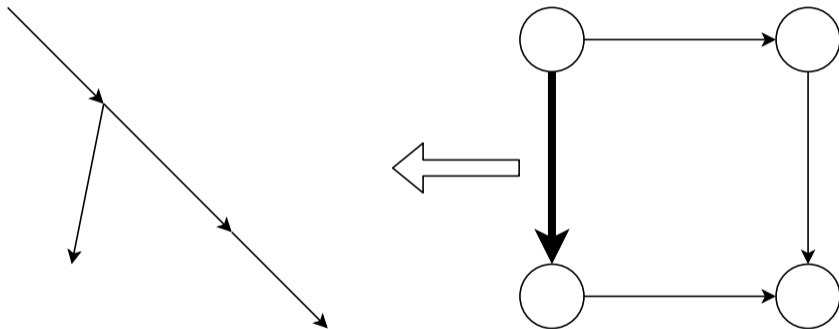

- Circuit de taille 2 autorisé
- Boucle interdite

# Déviation : interdiction

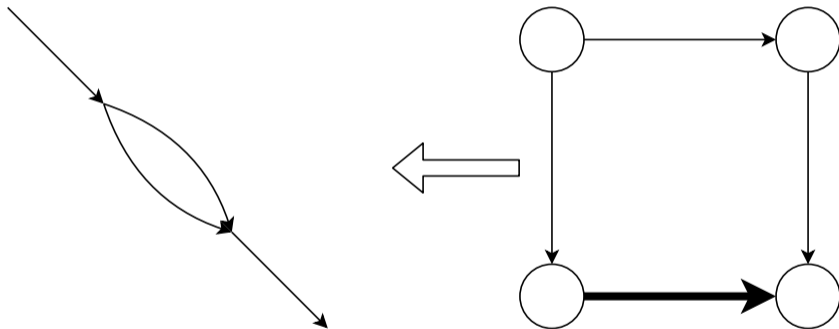

- Circuit de taille 2 autorisé
- Boucle interdite

# Huit : interdiction

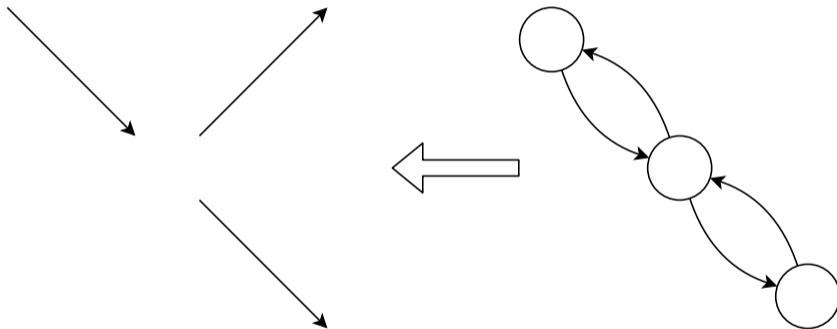

- Circuit de taille 2 autorisé
- Boucle interdite

# Huit : interdiction

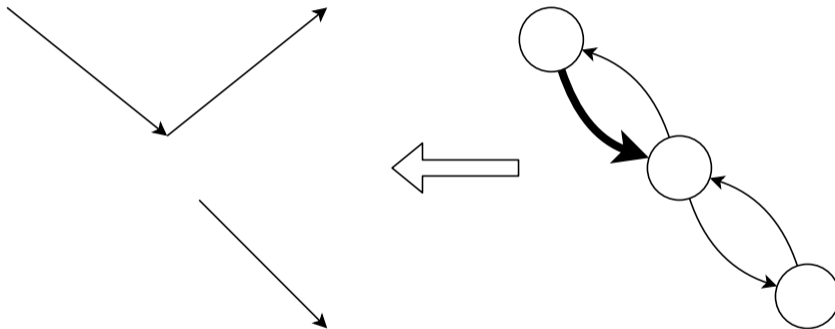

- Circuit de taille 2 autorisé
- Boucle interdite



# Huit : interdiction

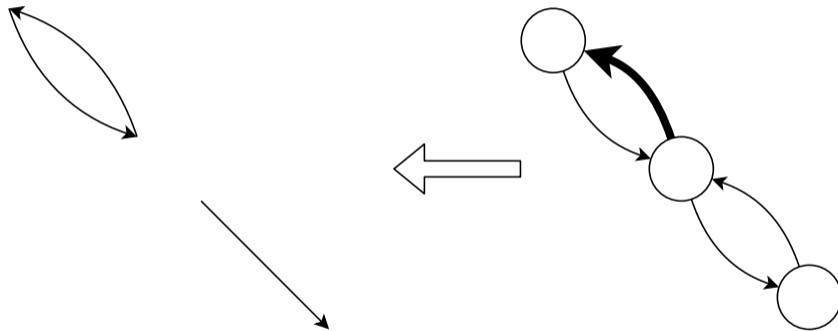

- Circuit de taille 2 autorisé
- Boucle interdite

# Huit : interdiction

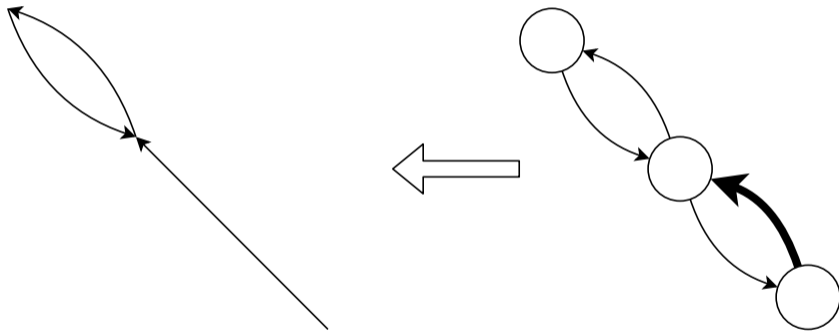

- Circuit de taille 2 autorisé
- Boucle interdite

# Huit : interdiction

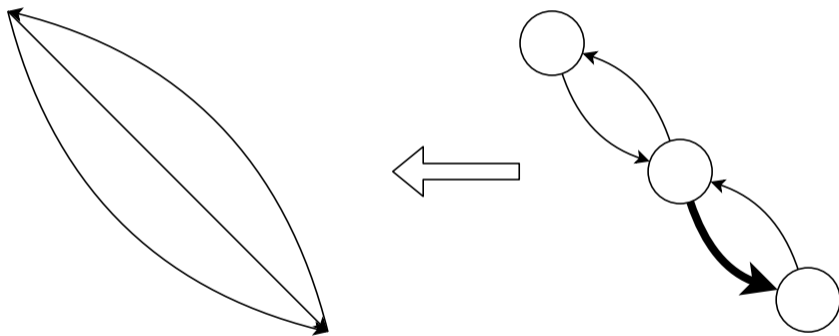

- Circuit de taille 2 autorisé
- Boucle interdite